

SPECIFICATIONS: NOTE ①

LOAD Z	LOW PASS	CROSS OVER	HIGH PASS	ATTENUATION
16	500HZ	800HZ	2KHZ	2KHZ
	LF -1	LF -4	LF -18	
	HF -11	HF -4	HF 0	0,-2,-4,-6,-8

CIRCUIT:

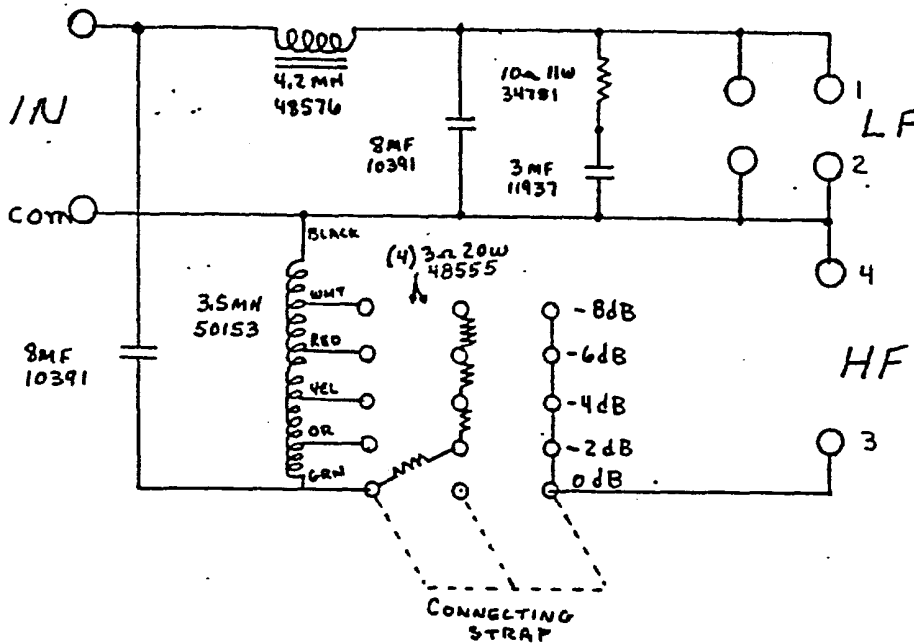

NOTES:

- ① USE STANDARD TEST FIXTURE

SPECIFICATIONS: NOTE ①

LOAD Z	LOW PASS	CROSS OVER	HIGH PASS	ATTENUATION
16	500HZ	800HZ	2KHZ	2KHZ
	LF -1	LF -4	LF -18	0,-2,-4,-6,-8
	HF -11	HF -4	HF 0	

CIRCUIT:

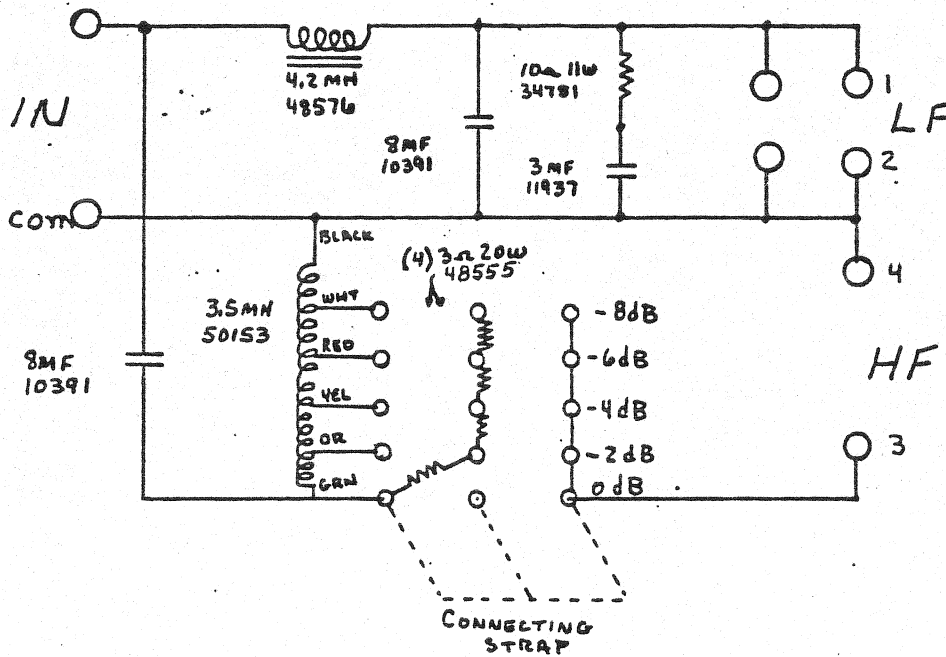

NOTES:

- ① USE STANDARD TEST FIXTURE

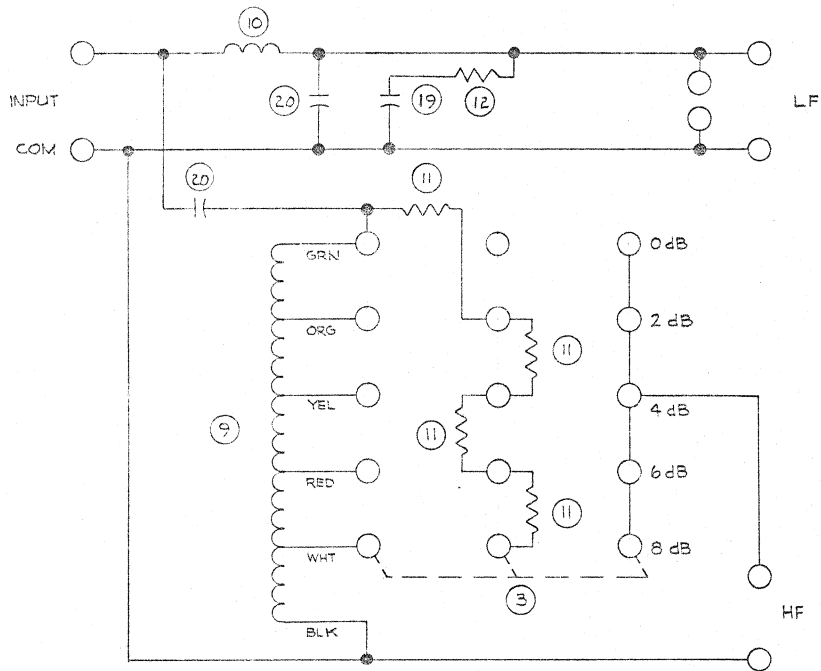

ITEM	QTY	DESCRIPTION	MRD
20	2	CAPACITOR, 8UF	
19	1	CAPACITOR, 3UF	
18	A/R	POTTING WAX	
17	1	WIRE, BLK, 20GA, 3 1/2 LG.	
16	2	WIRE, BLK, 20GA, 2 1/2 LG.	
15	1	WIRE, GRN, 18GA, 4" LONG	MRD 37051
14	1	WIRE, BLK, 18GA, 6" LONG	MRD 37055
13	4	SPEED NUT	
12	1	RESISTOR, 10Ω 1/2W	MRD 35491
11	4	RESISTOR, 3Ω, 20W	
10	1	INDUCTANCE COIL, 4.2 MH	
9	1	INDUCTANCE COIL, 3.5 MH	
8	4	SCREW, 6-32 x 1/4	
7	23	SCREW, 8-32 x 1/4	
6	4	STAND OFF, 6-32	
5	1	FOILCAL	MRD 35434
4	1	COVER PLATE	MRD 47139
3	1	SHORTING STRIP	
2	1	TERMINAL PANEL	
1	1	NETWORK CONTAINER	MRD 47145

3. FOR TEST SPECS SEE 51724 REF.

2. APPROVED ENG SAMPLE CURRENT REVISION MAINTAINED IN ENG DEPT.

1. SECURE COMPONENTS IN CONTAINER WITH POTTING WAX, ITEM 18.

NOTES:

REV	DATE	BY	DESCRIPTION	APP'D	CHK'D	DATE	BY	DESCRIPTION	SCALE	WEIGHT	SHEET	OF
1	2-22-65	DS	DELETE ITEM 15 CHANGE ITEM 20 TO 2 RED 10								1	1
2	3-22-65	DS										
3	5-25-67	AV										
4	10-25-68	DS										
5	4-23-65	DS										
6	10-25-68	DS										
7	2-22-65	DS										
8												
9												
10												
11												
12												
13												
14												
15												
16												
17												
18												
19												
20												

DECIMAL	FRACTIONS	ANGULAR
XX-01	XX-006	XX-002
TIR	MATERIAL	TREATMENT
1		MACHINE FINISH V
DO NOT SCALE DRAWING		

DRAWN: 3/11/67	6-30-67	JBL JAMES B. LANSING SOUND INC.
CHECK: R77	2/1/72	161 Angeles Calif 90039
DESIGN:		TITLE
ENGR:		MFD ITEM-3162 NETWORK
APP'D: DS	2-1-72	SIZE: C
		MFD ITEM
		DRAWING NUMBER: 48554
		REV: F
		SCALE: ---
		WEIGHT: ---
		SHEET 1 OF 1

# Professional Series Technical Manual

## Frequency Dividing Networks

3105	3120
3106	3125
3110	3152
3115	3182

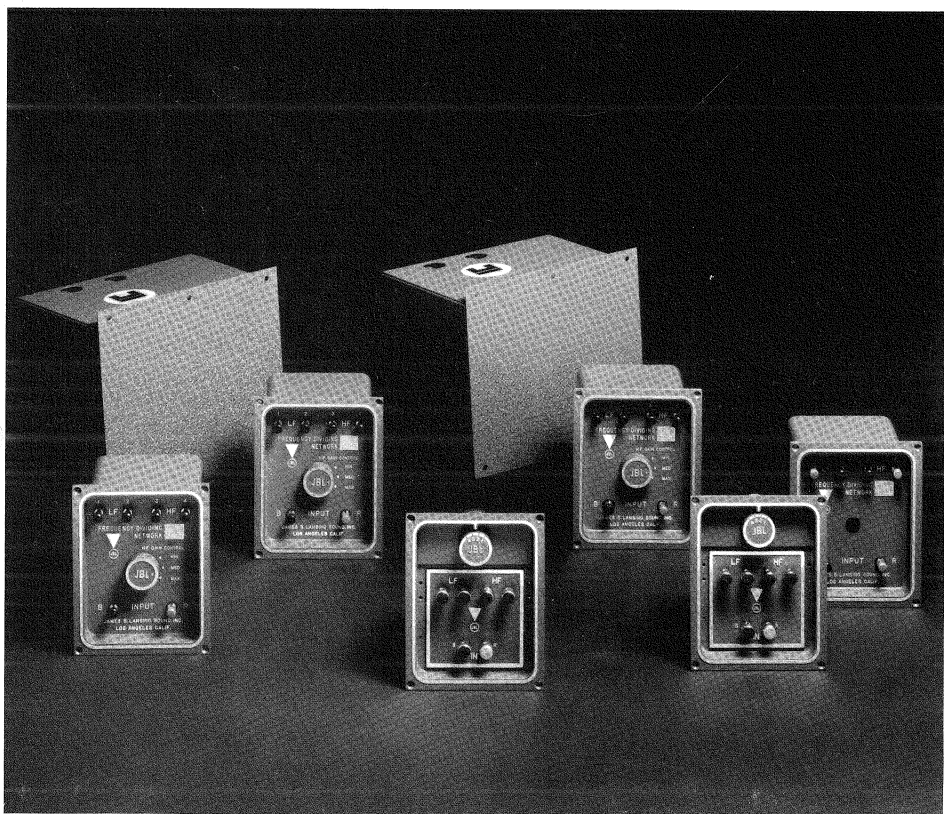

# Specifications

Model	Crossover	Power Capacity (Continuous Program) <sup>1</sup>	Impedance		High Frequency Attenuation	Shipping Weight	Net Weight
	Frequency		Low Frequency	High Frequency			
3105	7000 Hz	50 watts	12 - 16 ohms <sup>2</sup>	12 - 16 ohms	Continuously Variable	1 kg (2.25 lb)	0.7 kg (1.5 lb)
3106	8000 Hz	50 watts	12 - 16 ohms <sup>2</sup>	12 - 16 ohms	Continuously Variable	1 kg (2.25 lb)	0.7 kg (1.5 lb)
3110	800 Hz	100 watts	12 - 16 ohms	12 - 16 ohms	6-8-10 dB, switch	2.6 kg (5.75 lb)	1.9 kg (4.25 lb)
3115	500 Hz	100 watts	12 - 16 ohms	12 - 16 ohms	6-8-10 dB switch	2.7 kg (6 lb)	1.9 kg (4.25 lb)
3120	1200 Hz	75 watts	8 - 12 ohms	12 - 16 ohms	0-3-6 dB, switch	1.8 kg (4 lb)	1.1 kg (2.5 lb)
3125	1200 Hz	100 watts	For Model 2150 Only		Fixed	1.6 kg (3.5 lb)	1 kg (2.25 lb)
3152	500 Hz	250 watts	12 - 16 ohms	12 - 16 ohms	0-2-4-6-8 dB, strap	6.5 kg (14.25 lb)	5.5 kg (12 lb)
3182	800 Hz	250 watts	12 - 16 ohms	12 - 16 ohms	0-2-4-6-8 dB, strap	6.5 kg (14.25 lb)	5.5 kg (12 lb)

1. Continuous program power capacity is defined as 3 dB greater than continuous sine wave power (RMS).

2. Optimized for the 2440 driver. 3. Optimized for the 2410 and 2420 drivers.

## Introduction

JBL Professional Series high level passive frequency dividing networks are precision devices made with highest quality components throughout—non-inductive, non-polarized capacitors having high AC current capacity, built expressly for use in dividing networks; individually calibrated low-loss inductors; and heavy duty switches and resistors.

These networks have 12 dB per octave parallel L-C circuits. Additional conjugate elements are used to cancel out the inductive reactance of the low frequency loudspeaker. Since the 3105 and 3106 cross over above 5 kHz, additional conjugates are not needed.

The 3105, 3106, 3110, 3115, and 3120 are general application networks. The 3152 and 3182 are high power units designed primarily for theater, auditorium, or reinforcement applications. The 3125 is designed specifically for the 2150 composite transducer.

The 3105 is recommended for three-way systems using the 2440 driver for mid frequencies. The 3106 is designed for use in three-way systems involving the 2410 or 2420 drivers as mid frequency transducers.

## Applications

JBL frequency dividing networks can be used with many different combinations of drivers. The choice of network should be made on the basis of desired crossover frequency, power handling capacity, and impedance of both the low and high frequency drivers.

Matching the impedance of the drivers to the network is highly important, because the specified crossover point of the network is dependent upon correct driver impedances, as shown in Figure 1.

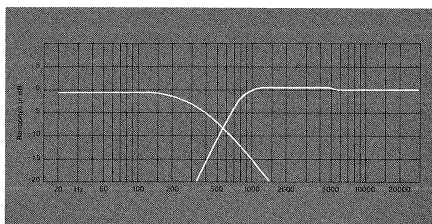
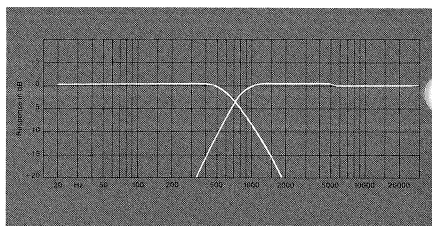

Figure 1. Properly and Improperly Matched Driver/Network Combinations

Selection of the network is based on the acoustical performance characteristics, acoustic loading, and properly matched impedances. JBL networks and drivers are designed to work together. Some drivers have actual impedances in their crossover regions which differ enough from the rated impedance to create mismatches with JBL networks, and their response can be quite different from what might otherwise be predicted.

It is not always possible to develop proper network load impedances with series and/or parallel driver interconnections. In such circumstances, the use of either the JBL 9375 autoformer or the secondary winding of the JBL 9308 70-volt line matching transformer between the network and drivers can be helpful in developing proper load impedances.

In some applications, connection of more than one network to the output of an amplifier may be required. Autoformers can be used for this application if the amplifier does not have the proper output impedances to match the network combination.

**Caution: Insulating the unused primary taps is strongly recommended whenever a 9308, or any 70-volt transformer, is used as an autoformer, since high voltages may be developed across the primary winding.**

## Power Capacity

JBL rates power handling capacity on the basis of continuous program, which is defined as 3 dB greater than the continuous sine wave rating. The continuous program rating is a conservative expression of the ability of the network and associated transducers to handle normal speech and music program material.

**Warning: Single frequency sine or square wave tones and pink or other noise sources are not normal program material. Care should be taken not to exceed the power handling capabilities of the transducers or the network when using these signals for testing purposes. Single frequency tone levels should be no greater than 3 dB below the continuous program rating. Pink noise levels should be no greater than 10 dB below the continuous program rating, due to the high crest factor of random noise sources.**

## Installation

### Mounting

*General Application*—General application networks can be mounted within a panel cutout or used as freestanding units. The mounting flange is fitted with a white vinyl gasket to maintain an air tight seal when the network is mounted in an enclosure panel, and is drilled for four 4 mm (#6) screws. A template is provided for the mounting cutout.

If the network is mounted in a low frequency enclosure, which is the most common usage, the cutout must be accurate within the specified tolerances, and the gasket must be properly positioned on the mounting flange. Mounting screws should be tightened just enough to prevent air leaks which would result in degradation of low frequency performance or spurious noises.

*High Power*—The high power networks are designed for surface mounting. The flange is drilled for six 4 mm (#6) screws; a mounting template is provided. The network case is 154 mm (6 in) high. Allow sufficient clearance above the case for cover removal, which will be required when making wiring connections or setting high frequency attenuation. Note the four 22 mm (0.875 in) holes in the container sides for wiring convenience.

## Connection

JBL networks and transducers are designed so that if the red terminal of each transducer is connected to the appropriate high terminal on the network (as shown in Figs. 2, 4 and 5) the system will be electrically in phase and diaphragm movements will be consistent. However, this arrangement may not result in proper acoustical phasing.

The connection resulting in proper acoustical phasing of any combination of components is difficult to determine in advance of assembly. Proper acoustical phasing of low and high frequency transducers will be that electrical phasing which produces maximum acoustic output through the crossover region. In general, if the diaphragms of the various transducers are in the same physical plane or arc, in-phase electrical connection will probably result in proper acoustical phasing. If the diaphragms are not in the same plane or arc, proper phasing should be determined experimentally, based on analysis of pink noise or subjective evaluation of program material.

For network connections up to 15 m (50 ft), 1.3 mm (#16 AWG) insulated wire is the minimum size recommended. Heavier gauge wire is recommended for greater distances: 1.6 mm (#14 AWG) from 15 m to 30 m (50 ft to 100 ft) and 2 mm (#12 AWG) from 30 m to 60 m (100 ft to 200 ft).

**Important: When connecting or disconnecting networks or transducers, the amplifier must be turned off. Making connections while the amplifier is operating could seriously damage the network or loudspeakers, and void the warranties.**

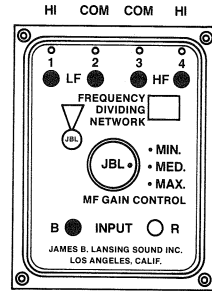

Figure 2. General Application Network Connection

Connections to general application networks are made at spring-loaded terminals. Press down on the terminals and insert the wires. Do not twist the terminals. Note that the wire holes do not go completely through these terminals.

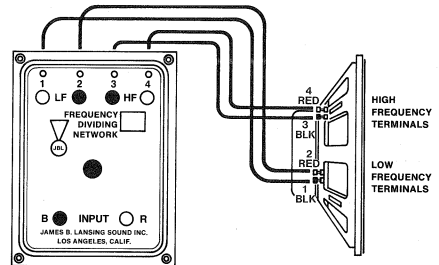

Figure 3. 3125 Connection

Connection to the 3125 network follows the general scheme of the other general application networks in Fig. 2 above, with the following difference: because the 2150 is acoustically phased properly when it is wired out of phase electrically, the terminals on the 2150 are numbered, and the numbered terminals on the network should be connected to the corresponding numbered terminals on the loudspeaker. Note that the low frequency color coding will be reversed. The black low frequency terminal on the network should be connected to the red low frequency terminal on the loudspeaker.

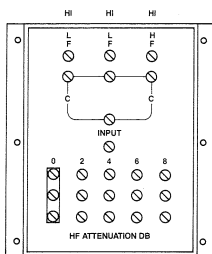

Figure 4. High Power Network Connection

Connections to the high power networks are made at screw terminals located under the top cover plate. Note that there are four common terminals, designated "C." These terminals are connected internally. The two LF high terminals are also internally connected, for convenience in wiring parallel low frequency transducers.

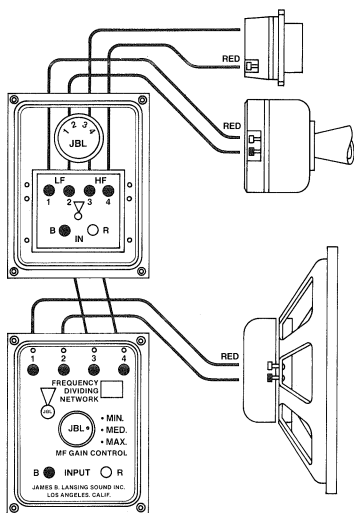

Figure 5. Three-Way System Connection

The connections shown for the components of a three-way system will result in correct electrical phasing. If the component voice coils, however, are not in the same plane or arc, proper acoustical phasing should be determined experimentally. Note that the attenuator of the mid-frequency network will vary the acoustic outputs of both midrange and high frequency drivers simultaneously.

## Adjustment

All networks are provided with a means for obtaining high frequency shelving. High power networks utilize a strapping bar across screw terminals labeled with the amount of attenuation achieved. The rotational controls used in general application networks—except the 3125, which is preset for the 2150 composite transducer—are designed so that maximum high frequency output is achieved with the knob rotated fully clockwise. The 3105 and 3106 are fitted with a continuously variable L-pad; the attenuation steps of the other controls are given in Table 1.

When connecting multiple drivers to a network, it may be necessary to separately adjust the acoustic output of individual drivers or groups of drivers. L-pads of the proper impedance and power handling capacity can be inserted in any leg of the system requiring attenuation in addition to that provided by the network. However, the total reflected impedance of all branches must match the network output impedance.

**Note: Frequency dividing networks are not protective devices—their function is to divide the audio spectrum among the transducers. The power handling capacity of the high frequency transducers, therefore, should be great enough so that they will not be damaged by the amplifier when the network is set for maximum output.**

Table 1. Attenuation of Network Step Controls

Model	Gain Control Setting		
	Min	Med	Max
3110	10 dB	8 dB	6 dB
3115	10 dB	8 dB	6 dB
3120	6 dB	3 dB	0 dB



JBL continually engages in research related to product improvement. New materials, production methods and design refinements are introduced into existing products without notice as a routine expression of that philosophy. For this reason, any current JBL product may differ in some respect from its published description but will always equal or exceed the original design specifications unless otherwise stated.



James B. Lansing Sound, Inc., 8500 Balboa Boulevard, Northridge, California 91329 U.S.A.

# Professional Series

## Frequency Dividing Networks

### Models

3105

3106

3110

3115

3120

3152A

3182A



High Power

General Application



JBL professional frequency dividing networks are intended for use with many high and low frequency driver combinations. The networks use 12 dB per octave parallel L-C circuits with additional conjugate elements to cancel the inductive reactance of the low frequency loudspeaker. Highest quality electronic components are used throughout – non-inductive, non-polarized capacitors having high AC current capacity built expressly for use in dividing networks; individually calibrated low-loss inductors, and oversize switches and resistors. High frequency shelving of networks crossing over below 7 kHz is accomplished with tapped autotransformers rather than conventional pads. The 3152A and 3182A are high power networks designed primarily for theater, auditorium or reinforcement installations; the others are for general applications.

[www.hifi-museum.com](http://www.hifi-museum.com)

**JBL**

# Frequency Dividing Networks

## Architectural Specifications

The high level dividing network(s) shall be of the 12 dB per octave type with provision for attenuating the high frequency driver in discrete steps. The circuitry shall consist of L-C sections with special provisions for minimizing the low frequency driver reactance. The inductors shall be wound on cores made of grain-oriented silicon steel laminations. In addition, networks crossing over below 7 kHz shall have a tapped inductor which allows autoformer action to be obtained for attenuation of the high frequency output.

Compensating parallel resistors shall be automatically selected for each tap so as to present a constant impedance to the input of the network when the high frequency driver is connected to the network. The network(s) shall be capable of handling 50 (75) (100) (250) Watts of program material power without overheating or clipping.

Model	Crossover Frequency	Watts Continuous Program <sup>1</sup>	Impedance Low Frequency	Impedance High Frequency	High Frequency Attenuation
<b>3105</b>	7000	50	16	16	Continuously Variable
<b>3106</b>	8000	50	16	16	Continuously Variable
<b>3110</b>	800	100	8-16	16	6-8-10 dB, Switch
<b>3115</b>	500	100	8-16	16	6-8-10 dB, Switch
<b>3120</b>	1200	75	8	16	0-3-6 dB, Switch
<b>3152A</b>	500	250	8	16	0-2-4-6-8 dB, Strap
<b>3182A</b>	800	250	8	16	0-2-4-6-8 dB, Strap

<sup>1</sup>Continuous program power is defined as 3 dB greater than continuous sine wave power (RMS). It is a conservative expression of the network's ability to handle normal speech and music program material.

**JBL** [www.hifi-museum.com](http://www.hifi-museum.com)

Professional Division

James B. Lansing Sound, Inc., 8500 Balboa Boulevard, Northridge, California 91329 U.S.A.

50713 SS3100/3-80 Printed in U.S.A.